

Project Name: _____
 Location: _____
 Engineer: _____
 Submitted to: _____
 Submitted by: _____
 Reference: _____

Approval: _____
 Date: _____
 Construction: _____
 Unit #: _____
 Drawing #: _____

Performance

Indoor Unit Model No: FAQ18PVJU
Outdoor Unit Model No: RZQ18PVJU9
Rated Cooling Capacity (Btu/hr): 18000
Sensible Capacity (Btu/hr): 13700
Max/Min Cooling Capacity (Btu/hr / kW): databook/databook
Cooling Input Power (kW): 1.607
SEER: 18.6
Rated Heating Capacity (Btu/hr): 20000
Max/Min Heating Capacity (Btu/hr / kW): databook/databook
Heating Input Power (kW): 1.962
Heating COP (Btu/hr / Btu/hr): 3.04
HSPF: 8.7

Indoor Unit Type: Wall Mounted
Condensing Unit Type: SkyAir Heat Pump
Rated Cooling Conditions
 Indoor: 80°F DB/67°F WB
 Outdoor: 95°F DB/75°F WB
Rated Heating Conditions
 Indoor: 70°F DB/60°F WB
 Outdoor: 47°F DB/43°F WB
Rated Piping Length(ft) 25
Rated Height Separation(ft) 0

Indoor Unit Details

Power Supply (V/Hz/Ph): 208-230/60/1ph
Power Supply Connections: L1, L2, Ground
Min Circuit Amps MCA (A): 0.4
Max Overcurrent Amps MFA (A): 15
Dimensions (HxWxD): 11-3/8x41-3/8x9
Panel (HxWxD): N/A
Net Weight (lbs): 31
Weight with Panel (lbs):

Airflow Rate (CFM wet coil) 500//400
Moisture Removal (pt/h):
Gas Pipe Connection (inch): 5/8
Liquid Pipe Connection (inch): 3/8
Condensate Connection (inch): 1
Sound Pressure Level (dBA): 43
Sound Power Level (dBA):
Static Pressure Rated/Max (inWg) 0 / 0/0

Condensing Unit Details

Power Supply (V/Hz/Ph): 208-230/60/1ph
Power Supply Connections: L1, L2, Ground
Min. Circuit Amps MCA (A): 16.5
Max. Overcurrent Amps MFA (A): 20
Max. Starting Current MSC(A):
Rated Load Amps RLA (A): 7.1
Dimensions (HxWxD): 30-5/16x35-7/16x12-5/8
Net Weight (lbs): 150

Compressor Type: Inverter
Capacity Control Range (%): 35 - 100
Airflow Rate (CFM): 1835
Gas Pipe Connection (inch): 5/8
Liquid Pipe Connection (inch): 3/8
Sound Pressure Level (dBA): 49
Sound Power Level (dBA):

System Details

Refrigerant Type: R-410A
Holding Refrigerant Charge (lbs): 5.1
Additional Charge (oz/ft): 0.036lbs/ft
Pre-charge Piping (Length ft): -
Max. Pipe Length (Total ft): 164 ft

Max. Pipe Length (Vertical ft): 98 ft
Cooling Operation Range (°F): 23 - 115
Cooling Range w/Baffle (°F): 0 - 115
Heating Operation Range (°F): 0 - 77
Heating Range w/Baffle (°F): 0 - 77

Project Name: _____
 Location: _____
 Engineer: _____
 Submitted to: _____
 Submitted by: _____
 Reference: _____

Approval: _____
 Date: _____
 Construction: _____
 Unit #: _____
 Drawing #: _____

Dimensional Drawing - Indoor Unit

FAQ18PVJU

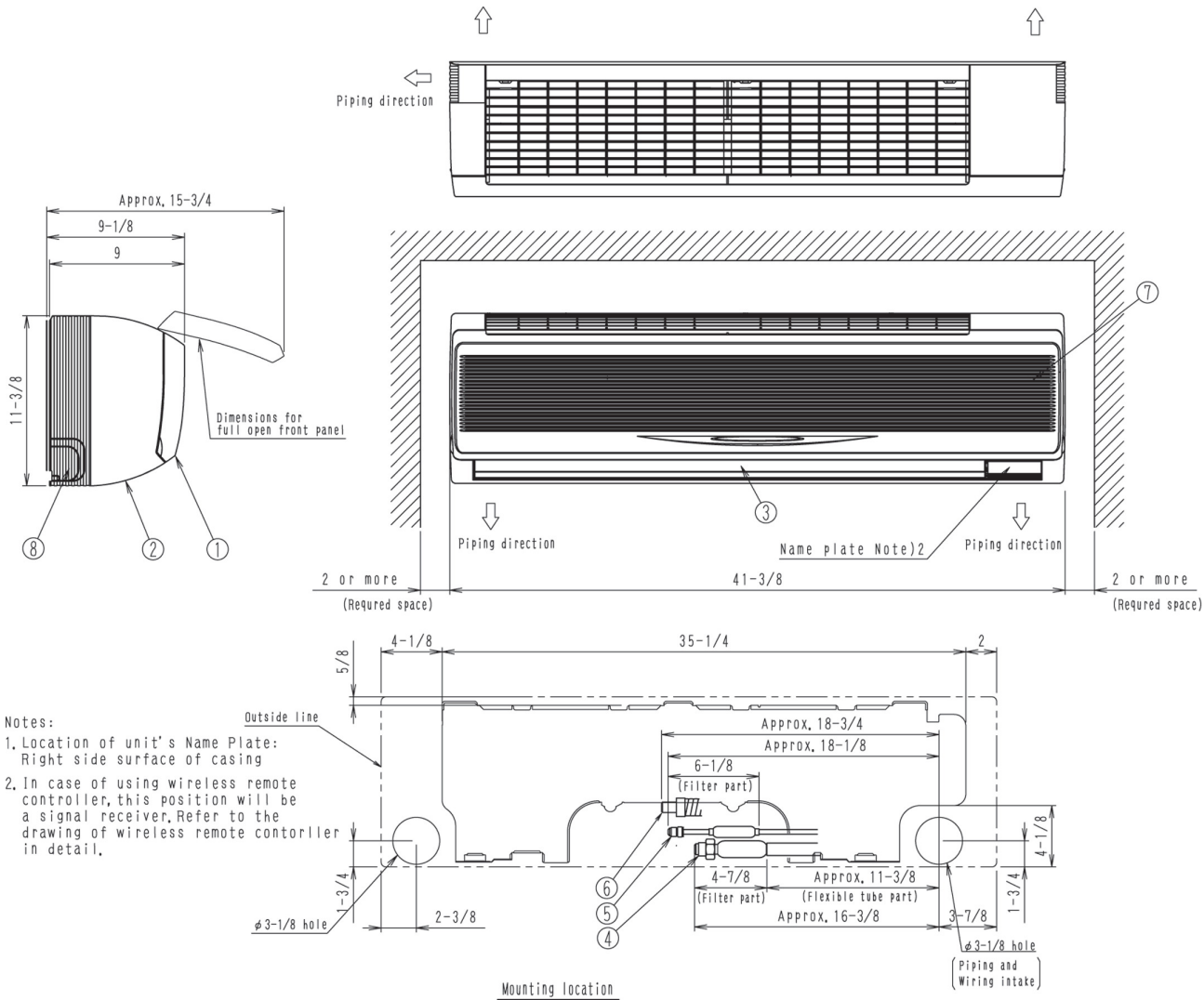

Project Name: _____
 Location: _____
 Engineer: _____
 Submitted to: _____
 Submitted by: _____
 Reference: _____

Approval: _____
 Date: _____
 Construction: _____
 Unit #: _____
 Drawing #: _____

Dimensional Drawing - Condensing Unit

RZQ18PVJU9

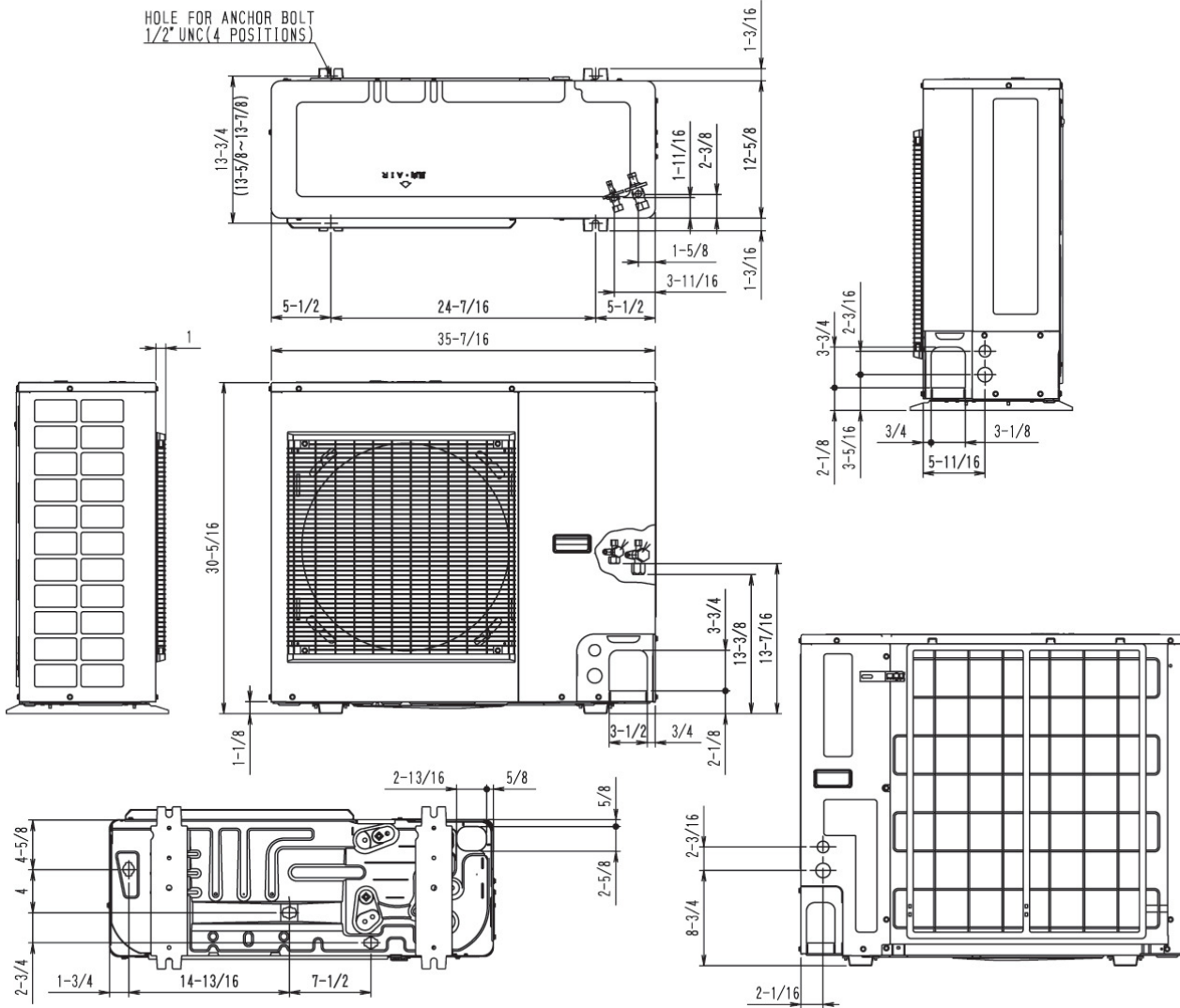

Project Name: _____
Location: _____
Engineer: _____
Submitted to: _____
Submitted by: _____
Reference: _____

Approval: _____
Date: _____
Construction: _____
Unit #: _____
Drawing #: _____

FAQ18PVJU



RZQ18PVJU9



FAQ18PVJU

Std U.S. Warranty: 7yrs Compressor, 5yrs Parts

RZQ18PVJU9

Std U.S. Warranty: 7yrs Compressor, 5yrs Parts